

Configuration

Dash #	Assy, TA360	Dash #	Assy, TA360	USB Connector
NON LIGHTED		LIGHTED		
6430360-1	-1	6430360-11	-11	Type A, C
6430360-3	-3	6430360-13	-13	Type C, C
6430360-7	-7	6430360-17	-17	Type C

Revision

ECO	Rev.	Description	Date	Approved
	A	Production release.	10/10/19	VAA/BAW

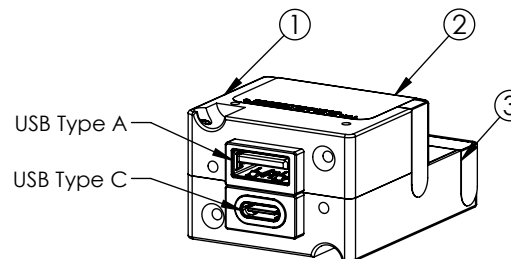
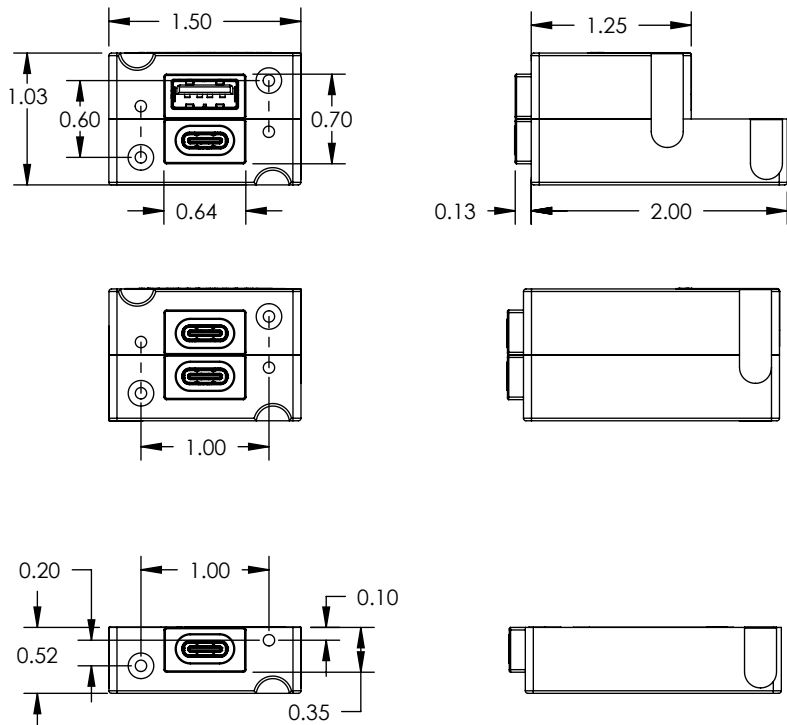

Config -1,11

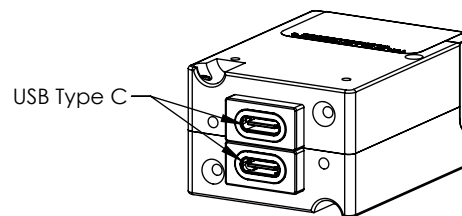
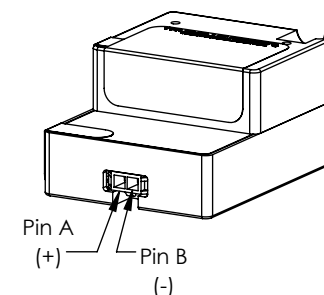

Config -3,13

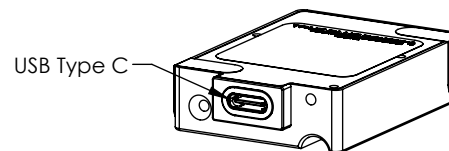
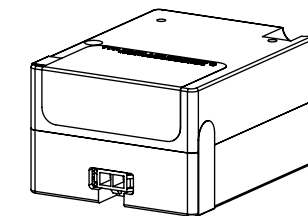

Config -7,17

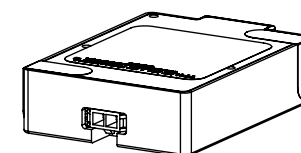

Specifications

Model Number	TA360	
Interface	USB Type-A	USB Type-C
Input	22-32 VDC, 18W	22-32 VDC, 66W
Output	5.0±0.25VDC; 3.0 A up to 15W;	Auto Adjustable 5, 9, 15, 20 VDC; 3A up to 60W
Standard	USB Battery Charging BC 1.2	USB Power Delivery Spec 3.0
Qualification	FAATSO-C71 RTCA DO-160G (See Installation Manual)	
Case	Anodized Aluminum, Black	
Mating Connector Kit	P/N 9017960	
Weight	1.0 oz (28g)-single port, 1.8 oz (51g)-dual A/C ports; 2.5 oz (71g)-dual C ports	
Installation Manual	P/N 9019411	

Connector Pinout	
A	22-32 VDC Input
B	Ground

UNLESS OTHERWISE SPECIFIED, ALL DIMENSIONS ARE IN INCHES.
TOLERANCE:
FRACTIONAL=±1/64
.XX=±0.015
.XXX=±0.005
.XXXX=±0.002
ANGULAR=±0.5°
WEIGHT N.T.E. +5%
BREAK ALL SHARP EDGES
THREADS PER MIL-S-7742

DRAWN:
VAA
03/22/2019

APPROVED:
BAW
10/10/2019

This document discloses proprietary information of Mid-Continent Instrument Co., Inc. It may be reproduced or disclosed only with written permission of Mid-Continent Instrument Co. and is not to be used in any way detrimental to the interests of Mid-Continent Instrument Co., Inc.

TITLE:
USB Power Delivery Charging Port

SCALE: 2:3

DO NOT SCALE THIS DRAWING

PART NUMBER:
6430360

SHEET: 1 of 1

Item	Qty	Part Number	Description
1	1	9019366-()	Assy, TA360 (See Config)
2	1	9019342-1	Nameplate, TA360
3	2	6018956-1	Decal, Warranty

TRUE BLUE POWER
A division of Mid-Continent Instrument Co., Inc.